



**NUEVA COLECCIÓN**  
RLC ENGINEERING

**2025**



# Campana led



## CAMPANA LED CLASICO COB 100W

Potencia: 100W

Color de temperatura: 5.000/5.500K

Voltaje: 85-265 (V)

Dimensiones: F400MMx400MMx420MM

Vida útil: 25000H

Lúmenes: 10.500LM

Material: Aluminio

Factor de potencia: 0.9

Garantía: 2 Años

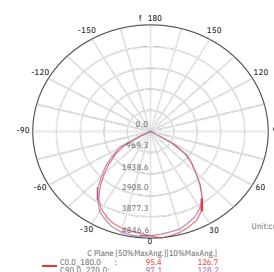
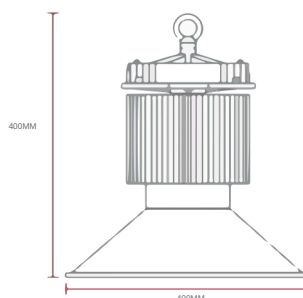

## CAMPANA LED CLASICO COB 150W

Potencia: 150W

Color de temperatura: 5.000-5.500K

Voltaje: 85-265 (V)

Dimensiones: F400MMx400MMx485MM

Vida útil: 25000H

Lumenes: 20.800LM

Material: Aluminio

Factor de potencia:  $\geq 0.9$

Garantía: 2 Años

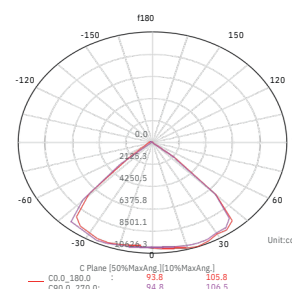
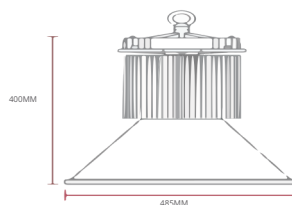



# Campana led



## CAMPANA LED CLASICO COB 200W

Potencia: 200W

Color de temperatura: 5.000- 5.500K

Voltaje: 85-265 (V)

Dimensiones:400MMx400MMx485MM

Vida útil: 25.000H

Lúmenes: 28.000LM

Material: Aluminio

Factor de potencia:  $\geq 0.9$

Garantía: 2 Años

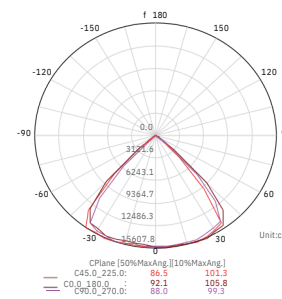
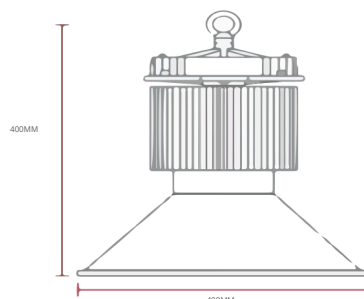

## CAMPANA LED CLASICO SMD 100W

Potencia: 100W

Color de temperatura: 5.000- 5.500K

Voltaje: 85-265 (V)

Dimensiones:485MMx485MMx300MM

Vida útil: 25.000H

Lúmenes: 12.000LM

Material: Aluminio

Factor de potencia: $\geq 0.9$

Garantía: 2 Años

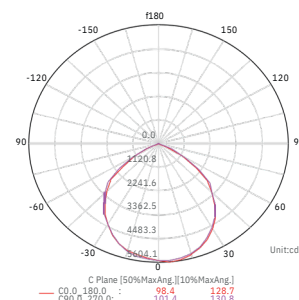
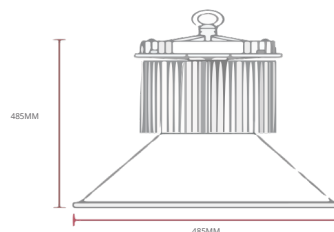



# Campana led



## CAMPANA LED CLASICO SMD 150W

Potencia: 150W

Color de temperatura: 5.000- 5.500K

Voltaje: 85-265 (V)

Dimensiones:485MMx485MMx300MM

Vida útil: 25.000H

Lúmenes: 18.000LM

Material: Aluminio

Factor de potencia:  $\geq 0.9$

Garantía: 2 Años

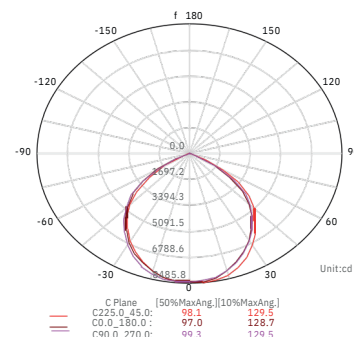
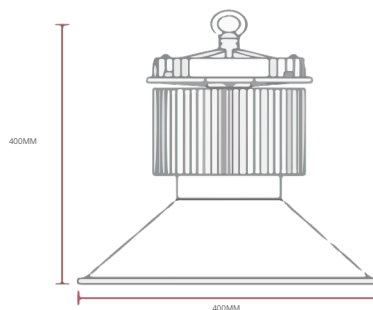

## CAMPANA LED CLASICO SMD 200W

Potencia: 200W

Color de temperatura: 5.000- 5.500K

Voltaje: 85-265 (V)

Dimensiones:490MMx490MMx340MM

Vida útil: 25.000H

Lúmenes: 23.800LM

Material: Aluminio

Factor de potencia:  $\geq 0.9$

Garantía: 2 Años

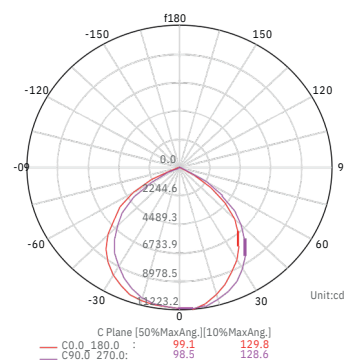
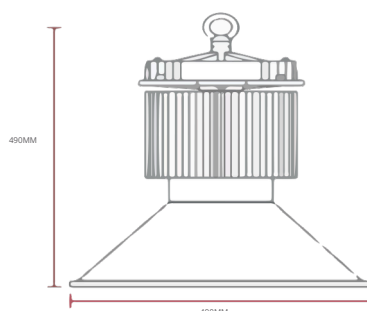



# Campana led UFO



## CAM PANA UFO PROHIGH 300W

Potencia: 300W

Color de temperatura: 5000K (FRIO)

Voltaje: 100-277 (V)

Dimensiones:  $\Phi$ 388MM\*257MM

Peso: 8.3KG

Vida útil: 100000H

Lúmenes:  $\geq$ 45000LM( $\pm$ 5%)

Ra $\geq$ 75

DRIVER: MEANWELL HLG

LED CHIP: NICHIA

IP: 65

THD  $\lt$ 15

Material: Aluminio

Factor de potencia:  $\geq$ 0.95

Garantía: 5 Años

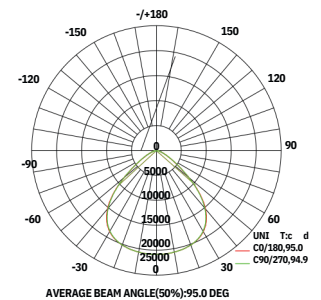

## CAM PANA UFO PROHIGH 200W

Potencia: 200W

Color de temperatura: 5000K (FRIO)

Voltaje: 100-277 (V)

Dimensiones:  $\Phi$ 388MM\*207MM

Peso:7.3KG

Vida útil: 100000H

Lúmenes:  $\geq$ 27000LM( $\pm$ 5%)

Ra $\geq$ 75

DRIVER:MEANWELL HLG

LED CHIP:NICHIA

IP:65

THD  $\lt$ 15

Material: Aluminio

Factor de potencia:  $\geq$ 0.95

Garantía: 5 Años

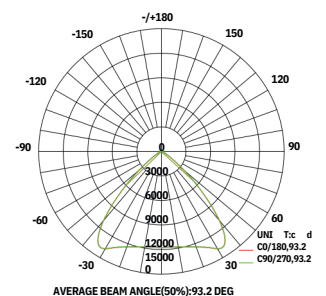



# Campana led UFO

## CAM PANA LED UFO PROGP 100W

Potencia: 100W  
 Color de temperatura: 5000K (FRIO)  
 Voltaje: 100-277 (V)  
 Dimensiones:  $\Phi 300\text{MM} \times 180\text{MM}$   
 Vida útil: 50000H  
 Lúmenes:  $\geq 16300\text{LM}$  (160LM/W)  
 DRIVER: MEANWELL  
 CHIP: LUMILED 3030  
 IP: 65  
 IK: 08  
 Material: Aluminio  
 Factor de potencia:  $\geq 0.95$ -**120**  
 Garantía: 5 Años

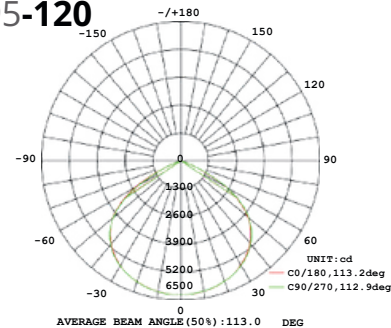
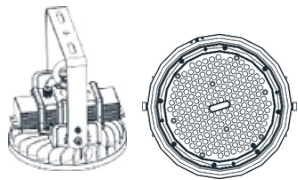

## CAMPANA LED UFO PROGP 150W

Potencia: 150W  
 Color de temperatura: 5000K (FRIO)  
 Voltaje: 100-277 (V)  
 Dimensiones:  $\Phi 330\text{MM} \times 192\text{MM}$   
 Vida útil: 50000H  
 Lúmenes:  $\geq 24000\text{LM}$ (160LM/W)  
 DRIVER:MEANWELL  
 CHIP: LUMILED 3030  
 IP: 65  
 IK: 08  
 Material: Aluminio  
 Factor de potencia:  $\geq 0.95$ -**120**  
 Garantía: 5 Años

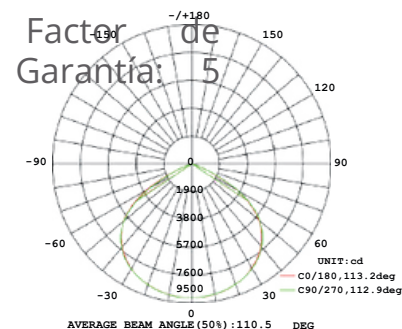
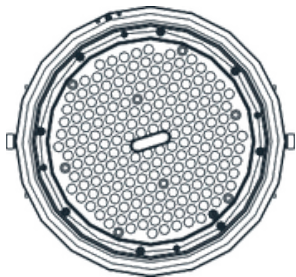



# Campana led UFO

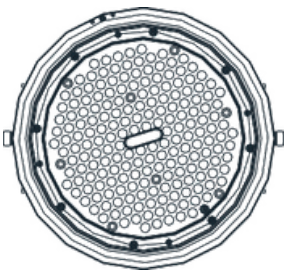

## CAMPANA LED UFO PROGP 200W

Potencia: 200W

Color de temperatura: 5000K (FRIO)

Voltaje: 100-277 (V)

Dimensiones:  $\Phi 330\text{MM} \times 192\text{MM}$

Vida útil: 50000H

Lúmenes:  $\geq 31000\text{LM}$  (160LM/W)

DRIVER: MEANWELL

CHIP: LUMILED 3030

IP: 65

IK: 08

Material: Aluminio

Factor de potencia:  $\geq 0.95$

Garantía: 5 Años

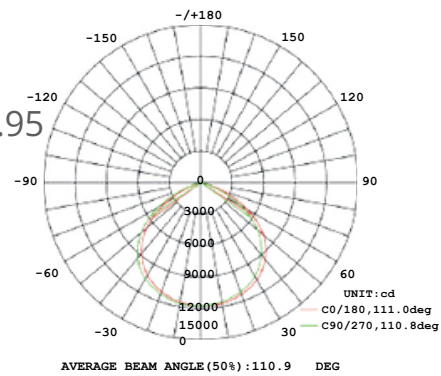



# Campana led UFO



## CAMPANA LED HIGHT BAY 150W

Potencia: 150W  
 Color de temperatura: 5700K  
 Voltaje: 100-240 (V)  
 Dimensiones:  $\Phi 340\text{MM} \times 150\text{MM}$   
 Vida útil: 25000H  
 Lumenes:  $\geq 15000\text{LM}$   
 Cri  $\geq 80$   
 Material: Aluminio  
 Factor de potencia:  $\geq 0.9$   
 Garantía: 2 Años

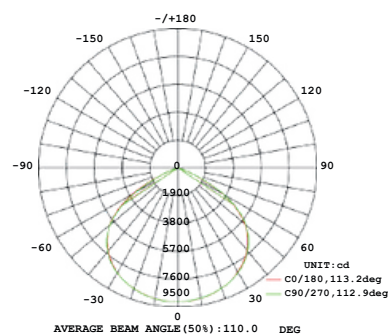

## CAMPANA LED HIGHT BAY 200W

Potencia: 200W  
 Color de temperatura: 5700K  
 Voltaje: 100-240 (V)  
 Dimensiones:  $\Phi 388\text{MM} \times 170\text{MM}$   
 Vida útil: 25000H  
 Lumenes:  $\geq 21000\text{LM}$   
 Cri  $\geq 80$   
 Material: Aluminio  
 Factor de potencia:  $\geq 0.9$   
 Garantía: 2 Años

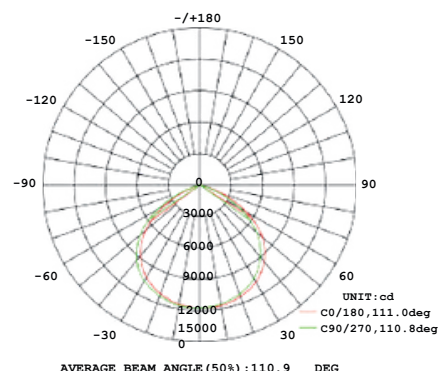





# RLC ENGINEERING

Los Mimbreros 5729, Peñalolén.

[rlc.enginnering.spa@gmail.com](mailto:rlc.enginnering.spa@gmail.com)

Fono: +569-6519-4137

Fono: +569- 8746-9460